

Design of Long Life Servo Valves

Moog's Approach to Design, Manufacture, and Construction of Feedback Mechanisms

Dan Baran

Moog

Engineering Service Manager for the Mechanical Feedback Servo Valve department

Key Messages

- The design, manufacturing and construction methods of the servo valve vary among suppliers and can make a difference in the life expectancy
- Test results show that Moog's use of the carbide, ball-in-hole feedback mechanism extends the lifetime of the servo valve when compared to products that use slotted spool and sapphire ball designs

Summary

The hydraulic servo valve is one of the most critical components in determining the performance of a hydraulic positioning, velocity or pressure control application. Highly dynamic and precise applications such as material testing, structural testing, simulation and plastics molding machinery have come to rely upon the accuracy, dynamic performance, and reliability of the latest hydraulic servo valve. It is in this context that we take an indepth look into some of most critical elements of an electrohydraulic servo valve.

The basic elements of the servo valve are the torque motor, flapper, spool, and feedback mechanism. The feedback mechanism is considered a critical component in a servo valve due to its role and the vast number of mechanical cycles it is subjected to over its lifetime. This mechanical component has undergone a tremendous amount of research and development to achieve life expectancies that are well above 1 billion cycles, but this is only achievable with the right selection of materials, manufacturing techniques, and mechanical designs.

Our white paper intends to provide the design engineer with the basic anatomy of a servo valve and evolution of the design since first invented by William C. Moog. Empirical test data demonstrating the value and the reasons for selection of materials, manufacturing techniques and mechanical solutions is also provided. You will also learn the reasons why this product is now more rugged and high performance than others in the marketplace .

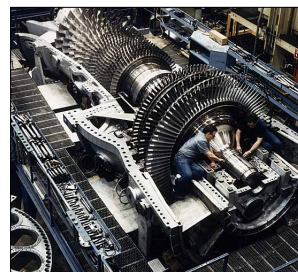
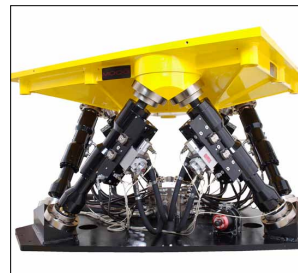

1 Rising Operational Costs Increase Importance of Motion Control Product Selection

Selecting the ideal motion control components remains central to achieving design goals in machine performance. Design engineers must evaluate each component's impact on the total lifecycle cost (TLC) of the machine.

Key Elements of Long Life Servo Valve Designs

- Carbide ball-in-hole technology in the mechanical feedback design has provided superior performance since 1994
- Carbide vs. Sapphire ball – Testing proves wear characteristics of carbide is comparable to sapphire ball and overall reliability in the field is better for carbide
- Moog's latest ball-in-hole design radically increases life expectancy over ball-in-slot version.

The selection of high quality components is critical to minimizing unplanned downtime. The cost of operational loss during unplanned downtime whether it is industrial production or transportation justifies the time it takes an engineer to evaluate the life expectancy of critical components on equipment. For example, test stands and flight simulators are valued in the millions of dollars and the unexpected failure of a servo valve or actuator translates into lost revenues and schedule delays that can often exceed the original equipment cost.

Experienced machinery design engineers know that selecting a hydraulic servo valve that provides a high degree of reliability is essential to preventing unplanned downtime. Moog's Servo Valves are often selected for quality and reliability and it is not uncommon for these products to be in active service for 25 years. While design engineers routinely select Moog Servo Valves for critical machine applications, many may not know

why these valves keep performing for such a long lifetime even in some of the world's most demanding applications such as steel production, test rigs, gas turbines and industrial production machinery.

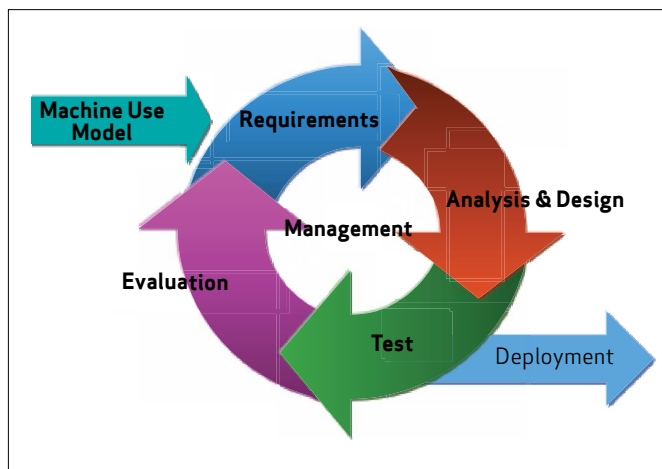

Figure 1 – Sequential, Iterative Design Model is Costly and Time Consuming

2 Servo Valves Dictate Dynamic Performance and Precision

The hydraulic servo valve is where the dynamic performance and precision positioning capabilities in a hydraulic motion control system are realized. As such the electrical design, mechanical design, material selection, and manufacturing process are all critical for ensuring the performance specifications of the servo valve are maintained over the expected lifetime. The servo valve is part of a closed-loop control system comprised of electromechanical mechanisms, and embedded software algorithms. It is incumbent upon the design engineer to fully understand the primary elements of this closed-loop system that impact the dynamic performance and life expectancy of a servo valve so he or she can make the best selection for the machine or application.

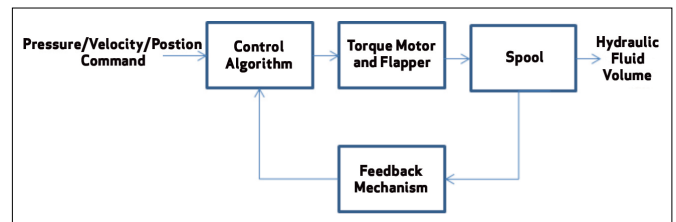

Figure 2 – Closed-Loop Hydraulic Servo Valve

3 Closed-Loop Servo Valve Technology Credited to Moog

The Moog Servo Valve was an innovation introduced by William C. Moog with a patent in 1951. This servo valve is sometimes called a Mechanical Feedback (MFB) Servo Valve to differentiate it from some valves that were developed later with on-board electronic feedback mechanisms. Prior to 1951, hydraulic valves were primarily open loop systems where the positioning of the spool was at best determined through empirical results in the laboratory under ideal conditions. However, in practice the controlled variable-pressure hydraulic fluid will have some variation over time leading to imprecise positioning of the spool in the chamber. The servo valve as an innovation that revolutionized the accuracy of industrial machines relied upon the introduction of the feedback mechanism used in the early hydraulic servo valve. The role of the feedback mechanism is to precisely determine the position of the spool in the valve and signal the stopping of the spool at a position that is proportional to the electrical input of the valve.

The Nozzle Flapper design of the Moog Servo Valve features a continuous flow of a small amount of fluid through two small nozzles facing each other. Between these jets is the flapper wire that is connected to the torque motor. The controller sends an electrical control signal to the torque motor, which in turn controls the opening of the nozzle-flapper interface to regulate the flow of the controlled variable-pressure hydraulic fluid from the two nozzles. The pressure from the hydraulic fluid will be directed to one side of a sliding valve referred to as the spool.

Closing the loop between the spool and the control algorithm incorporates the servo control that effectively revolutionized the industry.

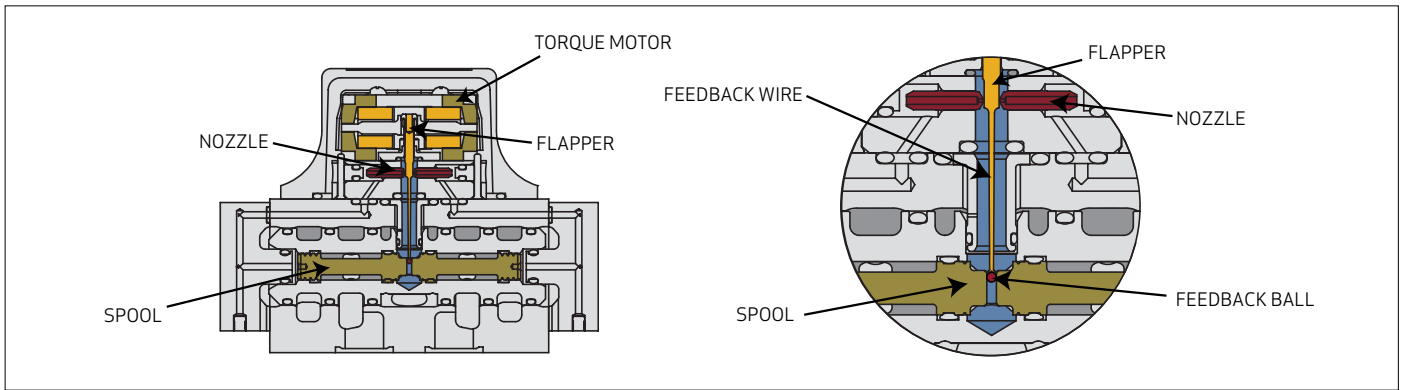

Figure 3 – Moog G761 Series Servo Valve Cutaway showing Ball-in-Hole Technology (See Section 6)

The spool is precisely machined to fit in a cylindrical chamber where it is displaced by the controlled variable-pressure hydraulic fluid. There are orifices in the cylindrical chamber that allow high-pressure hydraulic fluid to flow directly into the hydraulic cylinder. Accurately controlling the position of the spool in the chamber is critical to the precise delivery of high-pressure fluid to the cylinder.

The feedback mechanism is a cantilever spring with a spherical ball bonded to the end. The ball is in direct contact with the spool in the chamber and is deflected as the spool moves transversally in the cylinder. The position displacement of the spool provides the position feedback for the servo valve control algorithm. The control algorithm closes the position loop between the spool and valve flapper providing hydraulic equipment builders with precision control.

Servo valve vendors publish system specifications from the command input and output response. Each servo valve model is designed to achieve a specific performance criteria in terms of flow/pressure gain, frequency response, and precision while being subjected to wide spectrum of environmental and temperature ranges. This is about as far as most design engineers ordinarily go to make a product selection. For the engineer to assess that these performance specifications can be sustained throughout the life expectancy of the servo valve it is valuable to understand which components in the servo valve control loop are critical to early fatigue. Early fatigue in the internal servo valve components generally do not exhibit any external signs of degradation such as leakage. However, early fatigue definitively affects the dynamic performance of the servo valve. Once the servo valve is mounted in the equipment, most equipment operators will not be able to visually see any performance changes unless the system fails catastrophically.

It is valuable to understand which components in the servo valve control loop are critical to early fatigue. Early fatigue in the internal servo valve components generally do not exhibit any external signs of degradation such as leakage.

4 Ball-in-Slot Design Marked First Generation

As with all servo systems, the performance of the overall system is highly dependent upon the performance of the feedback mechanism. In a servo valve the elements of the system which have undergone considerable innovations are the feedback mechanism and spool, which are in direct mechanical contact, resulting in mechanical wear in each or both. Failure of the ball-in-slot technology can occur in as few as 100

million cycles when a life expectancy is a billion cycles. The wear in either ball or slot, prior to catastrophic failure, directly affects the dynamic performance of the servo valve. Potential symptoms of wear in the spool or feedback mechanism are exhibited as jitter, chatter, uncommanded motion, limit-cycling in control, dithering, oscillations, bang-bang control, and infinite gain response in the null area.

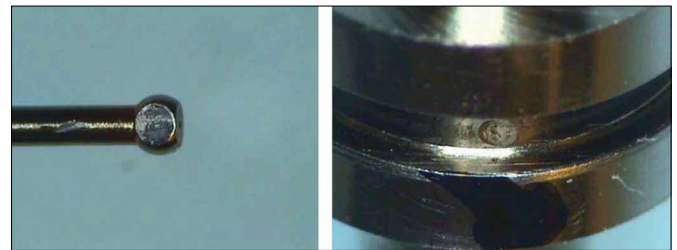

Figure 4 – Carbide Ball and Spool Wear in Slot

5 Carbide Replaces Stainless Steel

Designers of feedback mechanism and spools sought to overcome numerous sources of early wear in these critical components. The manufacturing processes used to produce the ball and spool are relying upon machining tolerances held in the submicron level for both the ball and spool because matching is critical. Despite the precision machining processes used, over the years servo valve performance degraded because of premature ball wear and circular rings along the edge of the slot in the spool. Early systems used stainless steel for the ball on the feedback mechanism, however by the mid-1990s, the carbide ball was introduced and remains the material with the highest performance characteristics in the field. A sapphire ball has also been used in the servo valve technology resulting in endurance characteristics that are comparable with carbide.

Tests conducted in Moog's R&D laboratory evaluated the wear characteristics of a steel, carbide, and sapphire ball by subjecting them to 1 billion test cycles. It also compared ball-in-hole and ball-in-slot configurations (See Section 6). In this controlled environment, hydraulic fluids were kept clean with temperatures held at a steady state throughout the testing.

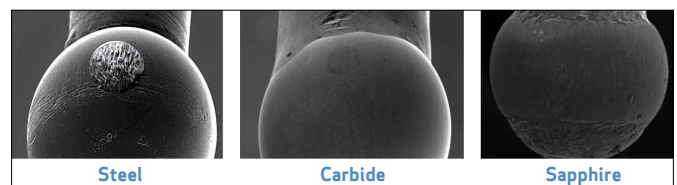

Figure 5 – Wear Test Results after 1 Billion cycles of Mechanical Feedback Balls; Carbide and Sapphire are Comparable while Steel has noticeable Wear

The test results confirmed that the carbide and sapphire ball do not show any signs of wear in this controlled environment, however the steel has noticeable wear (See Figure 5). The slotted spool used in this test experienced noticeable wear in all three cases. Researchers concluded that the reliability of the slotted spool design early wear characteristics are independent of the material used for the feedback mechanism ball. Test results reaffirm that the slotted spool configuration compromises the reliability of the servo valve.

6 Ball-in-Hole Technology Increases Life Expectancy

In terms of servo valve reliability, the sapphire and carbide ball are comparable. Both are excellent choices strictly from an endurance perspective (based on test results shown in previous section). The other factor to take into consideration is the method used to couple the feedback mechanism ball to the spool. Moog conducted extensive research and development on the servo valve to extend the lifetime of the feedback mechanism and spool. By 1998, further innovations were introduced with development of the carbide ball-in-hole technology. The materials remained the same, however a spherical seat is machined into the spool to the precise dimensions of the ball.



Figure 6: "Ball-in-Hole" Technology: Carbide ball extending through the hole in the spool

The manufacturing operation used to make the hole in the spool is referred to as "ballizing." "Ballizing" creates a hardened surface in the spool that exceeds the capability of heat treatment. The surface area of the carbide ball in contact with the spool is increased to reduce concentrated contact at any one point on the surfaces. Thus, it is a combination of mechanical design and a novel manufacturing process that

radically improved the life expectancy of the servo valve. The "ball-in-hole" technology has now replaced the slot cut into the spool. It did not take long before design engineers recognized the superiority of the carbide "ball-in-hole" technology and they began to demand this for all new applications. Since, 1998, the use of a carbide ball has remained state of the art, however new manufacturing techniques have been identified that extend the life of the feedback mechanism even further. Today over 95% of all Moog's MFB Servo Valves have been converted to "ball-in-hole" technology and the remaining are specialized valves waiting for international certifications.

Today 95% of all Moog MFB Servo Valves have been converted to ball-in-hole technology.

7 Validation of "Ball-in-Hole" Reliability

Despite the advantages of the "ball-in-hole" solution, there are legacy products and other valve manufacturer products that continue to use the slotted spool configuration. A second series of life expectancy tests demonstrates the superior performance of the "ball-in-hole" technology over "ball-in-slot." To reiterate the previous test results, the "ball-in-slot" mechanical configuration resulted in visible wear marks only in the spool slot in both the carbide and sapphire ball test cases after 1 billion cycles. Both the carbide and sapphire ball did not exhibit any signs of wear under magnification.

In this next analysis two different models of Moog's servo valves were evaluated. Both servo valve models were assembled with steel balls with the major difference being a "ball-in-slot" versus "ball-in-hole" configuration. The valves depicted in this test data were removed from installations in the field that had a up to 50,000 service hours. A post mortem was performed on each of the valves in order to measure the wear on the ball of each servo valve. The data depicted in Figure 7, "Distribution of Ball Spool Wear of Slotted vs. Ball-in-Hole", plots the distribution of ball wear of the ball-in-slot design and ball-in-hole design. The wear on the ball is distributed in a range of 0.0 to 8 mil (thousands of inch). While the wear specifically in the slot of the 'ball-in-slot' valve and the hole of the "ball-in-hole" were not measured directly in this analysis, the wear on the steel ball is used as a proxy. Furthermore, visual inspection was performed on the slot and hole to validate these assumptions.

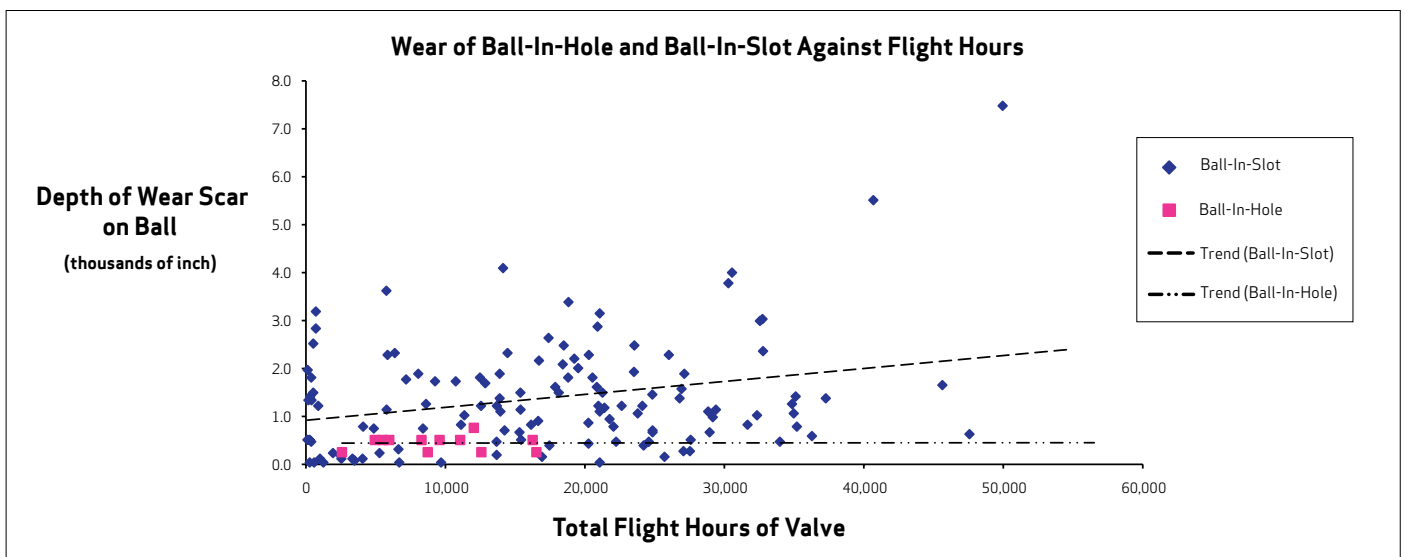

Figure 7 – Distribution of Ball Spool Wear of "Slotted" vs. "Ball-in-Hole"

The wear on the ball-in-hole remains well below 1mil for the duration of the test with a statistical variance near zero. In contrast, the ball-in-slot wear pattern is distinctly different in that the wear pattern has a wide statistical variance independent of the service hours. The fact is that the ball-in-slot configuration demonstrates wear patterns that are almost independent of service life. Specifically, the “ball-in-slot” has a number of instances of high wear in under 1000 hours in service. This is a result of early infant mortality in the servo valve suggesting the difficulty in maintaining manufacturing tolerances. Further investigation concluded that the wear in the ball-in-slot is the result of free rotation of the spool causing “adhesive wear.” Slow spool rotations between 1 to 4 RPM cause the most significant damage. These test results confirm that the ball-in-hole solution has far superior performance characteristics over the ball-in-slot.

8 Techniques Ensuring the Highest Reliability

Test results demonstrate that the optimal solution ensuring minimal ball and spool wear is the “ball-in-hole” configuration. However, there are other factors to consider to increase the reliability of the feedback mechanism. The feedback mechanism is composed of two separate pieces that must be attached in a manufacturing process. The primary reason for two separate pieces is that MFB wire requires the mechanical characteristics of a stiff spring whereas the ball requires hardness to minimize wear. To attach the stainless steel wire to the carbide ball there are two options that are available: (1) Brazing and (2) Epoxy.

Brazing

Brazing is a manufacturing process that can be applied when using a carbide ball and stainless steel wire. This is a soldering technique that joins the two materials, but is called brazing when the temperatures are above (842° F/450° C). Brazing is a metal-joining process whereby a filler metal is heated above melting point and distributed between two or more close-fitting parts by capillary action. The filler metal is brought slightly above its melting temperature. It then flows over the base metal and then cooled to join the work pieces together.

The critical part of this manufacturing process is to ensure that two pieces are free of contaminants and the surfaces match up as closely as possible while also maintaining the proper temperature to melt the filler (i.e. solder). Maintaining these three critical parameters makes the ball and wire joint stronger than the original materials.

Epoxy

Epoxy is used as an alternative to brazing when joining the feedback mechanism ball and wire. This is widely used when joining sapphire to a stainless steel wire. Sapphire cannot be brazed to stainless steel, so the only alternative bonding technique is epoxy. In perfect conditions, the epoxy is an equally viable manufacturing technique, however in the servo valve applications there are other factors that can cause unexpected failure. Most importantly, the chemicals in the hydraulic fluids can cause deterioration of the epoxy and there are indications that the epoxy breaks down even within the normal operating temperatures between 0°F/-17.7°C to 160°F/71° C.

The manufacturing process of the feedback mechanism is a major consideration when evaluating a servo valve. Specifically, the use of epoxy as joining technique may in fact be comparable to brazing in an ideal case. That is to say, ideal being that

cleanliness of the hydraulic fluid is maintained in a pristine or controlled condition. Secondly, the concern with regard to temperature susceptibility of the epoxy shouldn't be a risk that you need to take. In comparison, there are no known issues related to the bond created between stainless steel and the carbide ball using brazing.

9 Summary of Conclusions

The hydraulic servo valve has made tremendous improvements in reliability and life expectancy from the first introduction in 1951. The technological refinements have not changed the fundamental mechanical design of the servo valve. A multitude of refinements have led to these improvements. The selection of carbide material as ball on the feedback mechanism, the introduction of the “ball-in-hole” in the spool, and brazing used to bond the ball to wire are innovations that are the core to Moog's high performance servo valves.

Extensive test results demonstrate that carbide is as durable as sapphire, but has the advantage that it can be bonded to the feedback mechanism wire with a brazing process. Brazing bond between the wire and ball of the feedback mechanism enables this critical component to withstand deterioration from hydraulic fluid chemicals and high temperatures. However, the ball-in hole further extended the life of the servo valve by eliminating wear in the spool, ensuring that the servo valve will maintain reliable, accurate performance for a very long time while being resistant to deterioration and high temperatures in critical machine applications.

Critical Specifications of Servo Valves

- Carbide material as ball on the feedback mechanism
- The ball-in-hole in the spool.
- Brazing used to bond the ball to wire

10 Future of Hydraulic Servo Valves

The design of the feedback mechanism has continued to improve through R&D, experience in the field and expertise in manufacturing. In addition to Mechanical Feedback Servo Valves discussed in this paper, Moog also offers Proportional Valves with Electrical Feedback Mechanisms that offer advanced microprocessing and new possibilities for functionality. A combination of advanced control algorithms and improved position feedback has increased the dynamic performance and accuracy of the hydraulic valve to the benefit of many industrial applications.

Improvements in the servo and proportional valve continue to evolve with digital control algorithms compensating for nonlinearities that are inherent in hydraulic systems. In effect, a smart hydraulic valve is capable of providing higher bandwidth and greater positioning accuracy. Control parameters can be downloaded using a fieldbus or a high level PLC program allowing valve control functions to be tuned by a software interface even during the machine operating cycle. It also allows integrated continuous monitoring of a range of important valve and system functions and remote diagnostics for troubleshooting.

Key Innovations

- Advanced control algorithms improving dynamic performance
- Compensation for nonlinearities
- Fieldbus interface provides tuning during machine cycling

11 Information

For personal consultative expertise, contact a Moog representative in your region.

AMERICAS

USA +1 716 652 2000

Brazil +55 11 3572 0400

EUROPE

France +33 1 45 60 70 00

Germany +49 7031 6220

United Kingdom +44 168 429 6600

Russia +7 (83171) 3-18-11

ASIA PACIFIC

Australia +61 3 9561 6044

China +86 21 2893 1600

India +91 80 4057 6666

Japan +81 463 55 3615

Korea +82 031 764 6711

Singapore +65 677 36238

For your nearest Moog location, visit www.moog.com/worldwide

Author Biography

Daniel Baran, Engineering Service Manager for the Mechanical Feedback Servo Valve department. Dan has 10 years experience in pneumatic equipment design and production, followed by 34 years in the hydraulic field. Dan has both a BSME and MBA from the New York State University of Buffalo.

www.moog.com

©2012 Moog Inc.

Moog is a registered trademark of Moog Inc. All trademarks as indicated herein are the property of Moog Inc. and its subsidiaries. All rights reserved.

TJWhite/0512